



Descriptions

The USB mixer amplifiers have power ratings from, 60W, 120W to 240W. They are featured of three balanced microphone inputs, two aux inputs and one EMC input.

Priority muting is achieved via EMC input for overriding other inputs except Mic1 on front panel. Individual gain controls are provided for Mic 1-3 and Aux 1-2, bass and treble controls and master volume control are provided for overall tone control. 70V, 100V and low impedance 4-16ohms speaker outputs are provided. Extensive protection from short-circuit, overload and high temp.

Features

- * With USB port and fluorescent screen to display the sound number
- * Four function buttons: previous, play/stop, next and repeat
- * Remote control over USB for EQ, volume up, volume down & mute
- * Mixer amplifier for paging and background music system
- * In 2U height
- * 70V, 100V and low impedance 4-16ohm speaker output
- * 5 zone and all zone speaker terminals
- * Three balanced Mic inputs
- * Mic 1(phone jack) with VOX priority and VOX level on rear panel
- * Mic 2-3 by XLR type on rear panel with phantom power
- * Two Aux Inputs and 2 line inputs for spare use
- * One EMC priority input
- * EMC has priority over all inputs except MIC1
- * Mic 1-3, Aux 1-2 and master volume controls and bass/treble tone control
- * High temp, overload & short-circuit protection

Optional

- * DC 24V

Specifications

Model	TI-60BU
Rated Power Output	60W
Speaker Outputs	70V, 100V & 4~16Ω
Input Sensitivity & Impedance	MIC 1, 2, 3: 5mV/600Ω, Unbalanced phone jack input MIC 2, 3: ±2.5mV/2KΩ, Balanced XLR input MIC 2, 3: 775mV/10KΩ, Unbalanced RCA input AUX 1, 2: 350mV/10KΩ, Unbalanced RCA input EMC: 775mV/10KΩ, Unbalanced screw input
Output Sensitivity & Impedance	MIX OUT: 1000mV/470Ω, Unbalanced RCA output
Tone	Bass: ±10dB at 100Hz, Treble: ±10dB at 10KHz
Frequency Response	50Hz~16KHz(+1dB, -3dB)
S/N Ratio	MIC 1, 2, 3: 66dB, AUX 1, 2: 80dB
THD	Less than 0.1% at 1KHz, 1/3 rated power
Muting Function	MIC 1 overrides other input signals with 0-30dB attenuation
Gain Control	MIC2, 3 XLR, ±2.5mV~±75mV at 30dB
Crosstalk	≤ 50dB
MP3 Support Format	MP3
Maximum Support Capacity	8GB USB drive
Phantom Power	+48V, with LED indicator
Cooling	Fan automatically start up when temp reaches 55°C
Protection	High temp, overload & short-circuit
Power Supply	~110V/60Hz or ~230V/50Hz
Power Consumption	100W
Weight	7.2Kg
Dimensions	484x303x88mm
Finish	Panel: aluminum plate, black Case: steel plate, black

B Series(XLR Balance MIC Input + Phantom Power)

Rear Panel TI-60BU

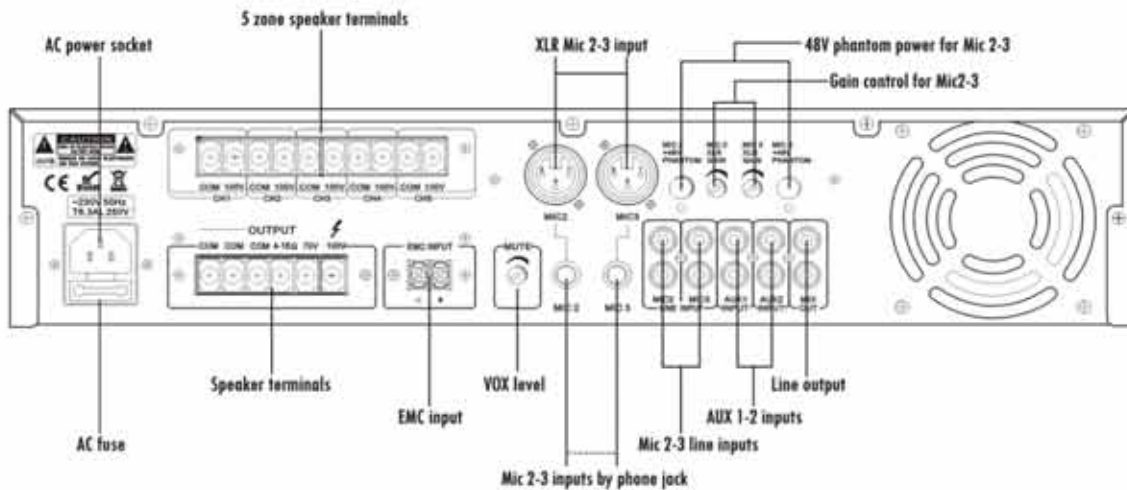

Connections

